



# *Range Rover*

## *Electronic Air Suspension*

|                  |                |
|------------------|----------------|
| APPLICABILITY    | <b>to 98MY</b> |
| DATE OF REVISION | 03/06/98       |



## **Introduction**

The electronically controlled air suspension (EAS) system allows different ride heights to be either manually or automatically selected. By changing the volume of air in each of the air springs, the system maintains ride height and quality regardless of load.

Four height sensors monitor vehicle height - one for each wheel. Data received from each sensor by the electronic control module is used to maintain, add or release air in each spring by a series of solenoid valves.

Seven valves work together in a valve block to manage system heights and air storage. An electric air compressor, regenerative air dryer, and a supply reservoir are used to manage the air used in the system.

Range Rover Classic and New Range Rover use basically the same system, differing only in a few details.



## **Table of Contents**

|   |           |
|---|-----------|
| <b>INTRODUCTION .....</b>                         | <b>2</b>  |
| <b>TABLE OF CONTENTS.....</b>                     | <b>3</b>  |
| <b>SYSTEM COMPONENTS.....</b>                     | <b>4</b>  |
| ELECTRONIC CONTROL UNIT (ECU).....                | 4         |
| BECM.....   | 4         |
| RELAYS AND FUSES .....                            | 4         |
| DISABLE SWITCH.....                               | 4         |
| CONTROL SWITCHES.....                             | 4         |
| HEIGHT SENSORS .....                              | 5         |
| AIR COMPRESSOR.....                               | 5         |
| AIR DRYER.....                                    | 5         |
| RESERVOIR.....                                    | 5         |
| PRESSURE SWITCH.....                              | 6         |
| VALVE BLOCK.....                                  | 6         |
| VALVE DRIVER.....                                 | 6         |
| AIR SPRINGS .....                                 | 7         |
| NYLON AIR HARNESS.....                            | 7         |
| <b>SYSTEM OPERATION .....</b>                     | <b>8</b>  |
| <b>SERVICE (RANGE ROVER CLASSIC).....</b>         | <b>9</b>  |
| SYSTEM CALIBRATION.....                           | 10        |
| SUMMARY OF AVAILABLE FAULT MESSAGES.....          | 10        |
| ECU SELF DIAGNOSTIC LIMITATIONS.....              | 11        |
| FAULT MESSAGE DIAGNOSIS .....                     | 12        |
| SYMPTOM DIAGNOSIS .....                           | 13        |
| <b>SERVICE (NEW RANGE ROVER).....</b>             | <b>14</b> |
| SYSTEM CALIBRATION.....                           | 14        |
| SUMMARY OF AVAILABLE FAULT MESSAGES.....          | 15        |
| ECU SELF DIAGNOSTIC LIMITATIONS.....              | 15        |
| FAULT MESSAGE DIAGNOSIS .....                     | 17        |
| SYMPTOM DIAGNOSIS .....                           | 18        |
| <b>RANGE ROVER CLASSIC CONNECTOR DETAILS.....</b> | <b>20</b> |
| <b>NEW RANGE ROVER CONNECTOR DETAILS .....</b>    | <b>25</b> |
| <b>PNEUMATIC DIAGRAMS.....</b>                    | <b>28</b> |
| <b>EXPECTED HEIGHT SENSOR BIT COUNTS.....</b>     | <b>32</b> |



### SYSTEM COMPONENTS

#### ELECTRONIC CONTROL UNIT (ECU)

The ECU, located under the right front seat on Range Rover Classic and the left front seat on New Range Rover, communicates with the vehicle through a 35-cavity connector. Serial data is available to retrieve fault messages and view real time data using TestBook. The ECU is very reliable due to input and output overload protection.

#### BECM

##### NEW RANGE ROVER ONLY

The BeCM provides basic inputs to the ECU, receives fault messages and controls the message center.

#### RELAYS AND FUSES

##### RANGE ROVER CLASSIC

The system incorporates two fuses and three relays, all located under the right front seat. A 30-amp 'maxifuse' is used to limit current to the compressor and diaphragm solenoid. A 15-amp fuse limits the ECU, valve driver, and pressure switch current. There is a four-pin compressor relay, a five-pin warning lamp relay, and a five-pin turn-off relay. The turn-off relay is used to maintain system power for approximately twenty seconds after the last door is closed. The relay "wakes up" every six hours to level the vehicle down to the lowest corner.

##### NEW RANGE ROVER

This system uses three fuses and one relay located in the under-hood fuse box. A four-pin compressor relay and a 30-amp 'maxifuse' are used for the diaphragm solenoid and compressor functions. A 10-amp fuse (F44) limits the ECU, valve driver and pressure switch current. Fuse F24 supplies the key-on signal. A six-pin delay turn-off relay is located under the left front seat. Power is maintained in the system for approximately one hundred seconds after the ignition is turned off or thirty seconds after the last door or tailgate is closed. This relay "wakes up" every few hours to level the system.

#### DISABLE SWITCH

##### RANGE ROVER CLASSIC ONLY

The disable switch is located on the back of the right front seat. This switch simulates a door open input to disable height changes by the ECU. The vehicle will gradually drop due to air leakage. For safety reasons, height changes are enabled at 35 mph.

#### CONTROL SWITCHES

##### RANGE ROVER CLASSIC

Two momentary contact switches and one latching switch are located on the driver's side of the dash. These switches are used to change ride position as well as indicate system status with integral lamps.

##### NEW RANGE ROVER

The rocker switches are located in the upper center console and are used to indicate current system status and make manual height changes.

## HEIGHT SENSORS

The height sensors are chassis mounted potentiometers that are connected via a link to the corresponding suspension member (e.g. trailing arm, radius rod). Each sensor modifies a five-volt reference voltage to report the height information to the ECU. This information is converted by the ECU to a digital format or "bits". Height information is available through TestBook as "bit counts".

## AIR COMPRESSOR

The electric air compressor has an internal thermal switch which protects the motor from overheating by signaling the ECU if the temperature exceeds 120° C. To meet altitude and pressure requirements the compressor has a compression ratio of 22:1.

### RANGE ROVER CLASSIC

The compressor, valve block, valve driver, and air dryer are attached to the chassis under the passenger's seat. Because these components are located below the wade height of the vehicle, the inlet filter is located in the right rear quarter panel.

### NEW RANGE ROVER

The compressor, valve block, valve driver, and air dryer are located under the hood on the left inner fender. A serviceable inlet filter is located on the compressor crankcase.

## AIR DRYER

The air dryer is located between the compressor and the reservoir. A diaphragm valve directs exhausting air through the dryer in the opposite direction, removing accumulated moisture from the dryer and thereby 'regenerating' the dryer. The mounting position of the dryer on New Range Rover models is vertical, taking advantage of gravity, to better expel moisture during the exhaust process.

## RESERVOIR



**CAUTION: The later style reservoirs (for both New Range Rover and Classic) have a different size drain plug. This will require an adapter when performing a pressure test on a later style reservoir. Use the following when doing the pressure test:**

- Early style—LRT-60-001
- Later style—LRT-60-001 and LRT-60-006

### RANGE ROVER CLASSIC

A ten-liter supply tank is attached to the chassis on the driver's side. One nylon air line serves as both inlet and outlet for the system. The reservoir should be depressurized and the drain plug removed and inspected for moisture at 30,000-mile intervals. If moisture is found, the dryer should be replaced. Two different reservoirs are specified depending on VIN: up to VIN SA654292 use NTC9825; from VIN SA654293 and up use ANR3754.

### NEW RANGE ROVER

A nine-liter supply tank is mounted to the chassis on the right side. As in the Classic, a single nylon line serves as both inlet and outlet. The inspection interval is also 30,000 miles, with dryer replacement required if moisture is encountered. As in the Classic, two reservoirs are specified depending on VIN: up to VIN TA340460 use ANR3645; from VIN TA340461 and up use ANR5135.

## PRESSURE SWITCH

The pressure switch is located in the valve block on both New Range Rover and Classic with the exception of Classic with a VIN up to SA654292. The pressure switch on these models is located on the air reservoir. The pressure switch contacts should be open at pressures below 7.6 BAR (110 psi). The pressure switch contacts should be closed at a pressure of 10.1 BAR (154. Psi) A deviation of  $\pm 0.4$  BAR (56 psi) is allowable for all pressure measurements.

## VALVE BLOCK

The valve block controls the flow of air in the system in response to decisions made by the ECU. This is accomplished through the use of solenoids, one-way check valves and a fabricated block or manifold. Six "hit and drop" solenoids (explained below) are used, one for each corner and one each for inlet and exhaust. One direct acting diaphragm solenoid is used to control the direction of airflow in the dryer and is energized by the compressor relay. A blow-off valve is located on the valve block in the event the system pressure exceeds 12.5 BAR (180 psi).

## VALVE DRIVER

The six solenoid valves are relatively large because of the response time required by the system. If these solenoid valves were operated for long periods of time under conditions of high temperature or high currents, they would overheat and fail. To prevent this, the valve driver controls the amount of current that flows through each solenoid coil. Because the current required to open the solenoid is considerably higher than the current required to hold the solenoid open, a "hit and drop" signal is used. Upon a valve open request the control voltage is near 0V for 0.050 seconds (50 milliseconds) then is pulsed to limit current through the coil. The pulsed voltage will read approximately 9 volts with a high impedance DVOM or can be viewed with an oscilloscope to be a 24 KHz 12-volt square waveform. The steady state current passing through each coil is approximately 1 amp.

*Solenoid driver hit and drop waveforms*

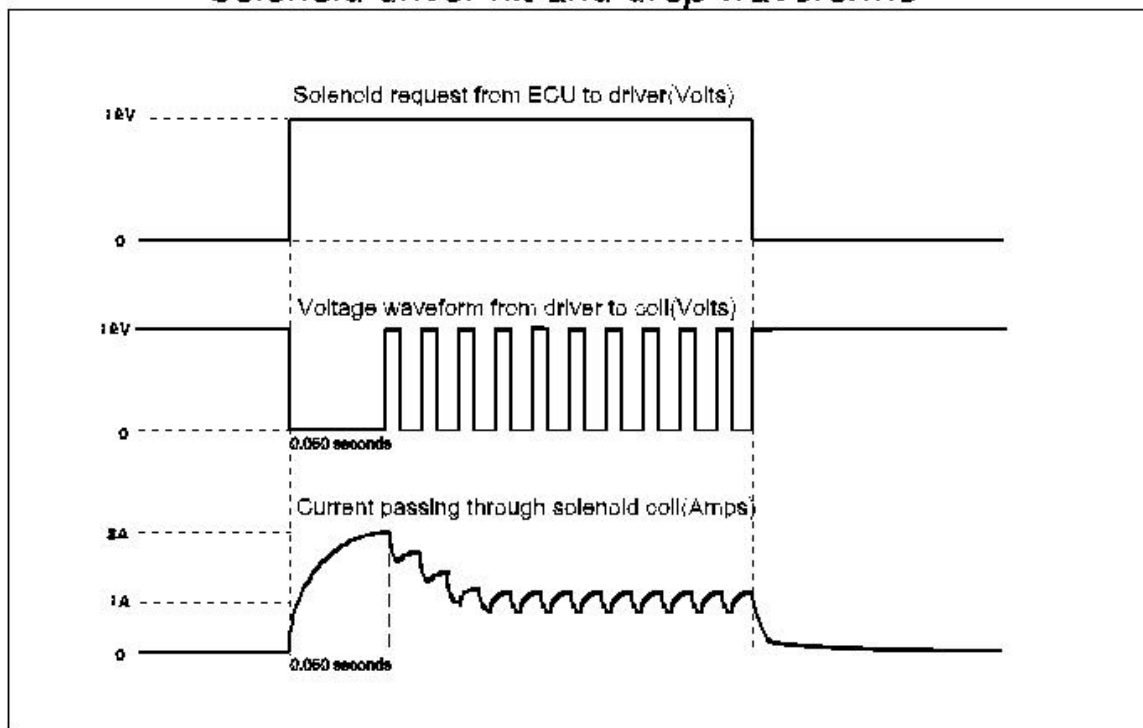



## **AIR SPRINGS**

The air springs are mounted in the same position as the conventional coil springs. The air spring unit consists of a top plate, a rubber diaphragm, and a lower piston. Front and rear air springs are not interchangeable. Upon failure the entire unit must be replaced.

## **NYLON AIR HARNESS**

All pneumatic components are connected by nylon air lines to maximize corrosion resistance and minimize fatigue failures. Each air spring and the reservoir are connected by a 6mm pipe which is repairable using part number STC8580.



### **SYSTEM OPERATION**

#### **DOOR OPEN “WAKE-UP”**

The system “wakes up” as soon as any door is opened. After all doors are closed, system leveling could take place if any height sensors actual value differs from its target value by more than  $\pm 2$  bits. The target value is determined by the lowest sensor input. If all the doors are then closed, the delay relay will time out in twenty seconds. Height changes are inhibited when any door (or tailgate on NRR) is open, up to a speed of 35 mph.

#### **ENGINE RUNNING “WAKE-UP”**

When the ignition key is turned to position II, the ECU wakes up again and another leveling could be required. On New Range Rover all warning lights are illuminated to indicate power without ECU activity, on Classic the lights illuminate at engine start. The system becomes active when the engine is started and the ECU receives an rpm signal greater than 500 rpm. The ECU will close the compressor relay and attempt to pressurize the reservoir. This attempt will take place if the pressure switch is open, the thermal switch is closed and the system is not trying to exhaust any air. Remember that air cannot enter and leave the system at the same time.

#### **IN GEAR HEIGHT REQUEST**

When the transmission is moved out of Park, the system will request Standard ride height. The ride height lamp will flash during this process. The compressor operation will be stopped if the vehicle exceeds 1 mph to allow the front axle to level. The leveling operation opens both front corner valves for only three seconds to allow pressures to equalize between the front air springs. This will be repeated every time the vehicle speed drops to zero. In stop-and-go traffic a lot of extra valve activity may be heard.

#### **BRAKE SWITCH INFLUENCE**

Brake switch input will interrupt the standard ride height request for three minutes (one minute on Classic). However, if the vehicle is travelling at 1 to 5 mph, the ride height change will be allowed in spite of the brake switch signal.

#### **COMPRESSOR OPERATION**

The compressor will continue to operate if the pressure switch remains open. If the compressor should become overheated, the thermal switch will open a path to ground and the ECU will shut the compressor down for a three-minute cool-down period. After three minutes have elapsed, the ECU will re-energize the circuit. If the thermal switch still has an open path to ground, another three-minute cool-down period will take place. This will continue until the path to ground is closed in the thermal switch indicating the cool-down has been successful. Once the cool-down is successful, the compressor will again operate.

#### **AUTOMATIC HEIGHT SELECTION**

The system will default to extended ride height if the system is unable to lower a sensor's bit count for any ten-second period, indicating the vehicle is “high centered”. A flashing high profile lamp will indicate extended ride height. The system will stay in this mode for ten minutes or until the operator manually requests a lower ride height. The system could also drop to standard if the vehicle speed exceeds 35 mph.

The system will automatically drop to low profile when the vehicle speed exceeds 50 mph for more than thirty seconds. The lower lamp will be illuminated. This automatic feature should be cancelled while towing by depressing the standard height button. This feature can be selected at any speed on Range Rover by pressing the inhibit switch and the down rocker switch.





### SERVICE (RANGE ROVER CLASSIC)

The most useful tool available to repair any EAS problem is TestBook. The system is only trying to make four sensors stay within a defined error range. Each rear sensor individually should be within 2 bits of its target value while the front sensor values are averaged. See TIB 60/02/94/US

The TestBook menu offers the following utilities:

**CALIBRATE**—This routine should only be performed when a height sensor or ECU has been replaced.

**DEFLATE**—Used to depressurize the system; this function will not work if the inlet or exhaust solenoids have failed.

**DYNAMIC TESTS**—Provides real-time serial data for each subroutine.

- Heights and Valves—Height sensor data.
- Switches—All input switch data.
- Compressor and Speeds—Input and output data

**SYSTEM TEST**—Read faults, performs complete system functionality test including pressure switch

**VALVE CYCLING**—Used to manually open valves and run the compressor.

The current CD does not provide selection for 93 and 94 model year. This is because the first three questions under *System Test* make reference to a lamp in the instrument pack that doesn't exist for these model years. To access this utility, use the following procedure:

#### **TestBook screen 1:**

Ensure ignition is OFF.

Does Air Suspension warning lamp in instrument pack illuminate?

**Answer:** NO.

#### **TestBook screen 2:**

Ensure inhibit switch is not depressed. Turn ignition to position 2. Do not start engine.

Does Air Suspension lamp illuminate?

**Answer:** NO.

#### **TestBook screen 3:**

Disconnect Black diagnostic connector.

Does Air Suspension warning lamp illuminate?

**Answer:** YES.

You will then be prompted to initialize the ECU. If further problems are experienced, refer to page 12 of this document to locate the problem.



RANGE ROVER CLASSIC SERVICE cont.

### SYSTEM CALIBRATION

In an effort to adjust for variations between sensors and their locations on the chassis, it is necessary to calibrate the vehicle's body to specific sensor bit counts. This is accomplished by supplying height measurements to specific height sensor outputs. At the start of the routine, all existing sensor target values are over-written with new default values. This way a consistent starting point is used with all vehicles.

During the calibration routine both the pressure switch and the thermal switch are ignored. The routine should be completed as quickly as possible in order to avoid potential compressor damage. If the first attempt fails, your new calibration data points become those calculated by the ECU during the first attempt. This enables further "tuning" to reach the final goal of  $790 \pm 7\text{mm}$  at Standard Ride Height (See TIB 60/02/94/US).

### SUMMARY OF AVAILABLE FAULT MESSAGES

|                                |                                |
|--------------------------------|--------------------------------|
| FRONT LEFT SENSOR ABOVE LIMIT  | FRONT LEFT SENSOR BELOW LIMIT  |
| FRONT RIGHT SENSOR ABOVE LIMIT | FRONT RIGHT SENSOR BELOW LIMIT |
| REAR LEFT SENSOR ABOVE LIMIT   | REAR LEFT SENSOR BELOW LIMIT   |
| REAR RIGHT SENSOR ABOVE LIMIT  | REAR RIGHT SENSOR BELOW LIMIT  |
| ENGINE SPEED                   | VEHICLE SPEED                  |
| PRESSURE SWITCH STUCK ON       | PRESSURE SWITCH STUCK OFF      |
| COMPRESSOR FAILURE             | AIR SUPPLY LEAK                |
| CANNOT LOWER FRONT LEFT        | CANNOT LOWER FRONT RIGHT       |
| CANNOT LOWER REAR LEFT         | CANNOT LOWER REAR RIGHT        |
| FRONT LEFT VALVE STUCK OPEN    | FRONT RIGHT VALVE STUCK OPEN   |
| REAR RIGHT VALVE STUCK OPEN    | REAR LEFT VALVE STUCK OPEN     |
| INLET VALVE STUCK OPEN         | EXHAUST VALVE STUCK OPEN       |
| FRONT LEFT VALVE STUCK CLOSED  | FRONT RIGHT VALVE STUCK CLOSED |
| REAR LEFT VALVE STUCK CLOSED   | REAR RIGHT VALVE STUCK CLOSED  |
| INLET VALVE STUCK CLOSED       | EXHAUST VALVE STUCK CLOSED     |



RANGE ROVER CLASSIC SERVICE cont.

### ECU SELF DIAGNOSTIC LIMITATIONS

The ECU may seem to misdiagnose a problem. This is due mainly to the limited number of inputs on which to base decisions. Because of the similarity of symptoms, multiple faults may be registered where only one is actually present. The following is a summary of alternative interpretations of a registered fault message:

- Height sensor above or below has no alternatives.
- Engine speed has no alternatives.
- Road speed has no alternatives.
- Front valve stuck open has no alternatives.
- Rear valve stuck open has no alternatives.
- Inlet valve stuck open has no alternatives.
- Pressure switch on may be confused with inlet valve stuck closed or rear valve stuck closed.
- Pressure switch stuck off may be confused with compressor failure or air supply leak.
- Compressor failure may be confused with inlet valve stuck closed, exhaust valve stuck open or air supply leak. These four messages may be set interchangeably.
- Front valve stuck closed may be confused with inlet valve stuck closed or exhaust valve stuck closed.
- Rear valve stuck closed may be confused with inlet valve stuck closed or exhaust valve stuck closed.
- Exhaust valve stuck closed may be confused with front valve stuck closed or rear valve stuck closed.

Pay particular attention to sensor outputs over the vehicle's range of suspension travel (See TIB 60/05/95).

Perform *System Test*. TestBook will generally find the problem.

The diagnostics following will be divided into two categories:

**FAULT MESSAGE DIAGNOSIS** – This will give an explanation of what sets the message and some suggested TIB references as well as information relevant to the message.

**SYMPTOM DIAGNOSIS** – To be used in case of the absence of fault messages or warning lamp illumination. Probable causes of symptoms will be provided.



RANGE ROVER CLASSIC SERVICE cont.

### FAULT MESSAGE DIAGNOSIS

#### ANY HEIGHT SENSOR ABOVE OR BELOW LIMIT

This is set when a specific sensor is detected operating outside of its allowable operating range. Select *Dynamic Tests/Heights and Valves* to view sensor readings. Also refer to TIBs 60/04/95/US and 60/05/95/US to help locate the defective component.

Verify sensor readings over the entire range of suspension travel. The lower limit is 40 bit counts and the upper limit is 225 bit counts.

#### ANY CORNER VALVE STUCK OPEN, CLOSED, OR CANNOT LOWER

This is set when the system is unable to make a sensor's output reach its demanded value. Select *Air Suspension/Valve Cycling* to determine whether the corner flagged will move up or down. Don't forget to run the compressor for a few minutes to build air pressure in the reservoir. If the corner moves, refer to TIBs 60/09/95/US and 60/05/95/US to locate the defective component. If it does not move, refer to TIB 60/09/94/US to determine specifically which component is at fault. It is highly unlikely that both the valve block and valve driver could fail at the same time. Early VIN vehicles may not have valve blocks and valve drivers available separately.

#### INLET VALVE STUCK CLOSED OR EXHAUST VALVE STUCK OPEN

This is set when the system is unable to make more than one sensor's output reach its demanded value. An air leak or a weak compressor could also set this. Select *Dynamic Tests/Heights and Valves* to determine the cause. Also, refer to TIB 60/02/95/US when operating in cold climates. Refer to TIB 60/09/94/US for more details.

#### PRESSURE SWITCH STUCK ON (CLOSED) OR OFF (OPEN)

These messages are set when the air usage does not correspond to the implied air pressure. Remember that the system has no way of determining the actual air pressure. Perform a Pressure Switch Test using TestBook and LRT-60-001 pressure gauge to verify switch operation.



**NOTE: Later version reservoirs will require adapter LRT-60-006 because of different sized drain plug.**

The results should be open to closed at 10 BAR (140 psi) and closed to open at 8.5 BAR. (125 psi) It should take roughly six minutes for an empty system to reach 10 BAR (140 psi) with the driver's door open. Refer to TIB 60/07/94/US.

#### ENGINE SPEED OR VEHICLE SPEED

A signal from the alternator (phase tap) is used to determine engine speed, while the signal from the vehicle speed sensor is used to determine road speed. The fault messages are set when the ECU sees values for either speed above a set limit. Use any icon under *Dynamic Tests* to locate the problem. Verify that the latest speed sensor is installed (see TIB P93//68-003).

#### AIR SUPPLY LEAK OR COMPRESSOR FAILURE

This fault is set when the system is unable to bring more than one sensor to its target and the pressure switch remained off during that time. Use *Health Check* and *Dynamic Tests* to locate the cause.



RANGE ROVER CLASSIC SERVICE cont.

### SYMPTOM DIAGNOSIS

#### THE SYSTEM WILL NOT INITIALIZE

TestBook establishes communications during power-up of the ECU, pressing the initialize button momentarily interrupts the power allowing TestBook to start communications.

Check that the delay relay clicks when the initialize button is pressed. If it does not, check the power and ground to the relay. If the relay is functioning properly, the power supply to the VCSI "brick" must be confirmed. Current flow should be approximately 40 mA when checked at the battery positive terminal. Confirm that TestBook is functional by trying it on another vehicle.

#### THE COMPRESSOR DOES NOT RUN

All of the following must be true for the compressor to run:

- The engine speed must achieve 500 rpm and then cannot drop below 150 rpm.
- The pressure switch must be open.
- The thermal switch must be off (closed, grounded).
- The exhaust valve must be closed, no height changes taking place.
- The compressor relay must be closed and the 30-amp 'maxifuse' must be intact.

#### SYSTEM DOES NOT BUILD PRESSURE FAST ENOUGH

Connect TestBook. Select *Air Suspension* and perform a *Health Check*. Use the pressure switch test to validate all system components. A rough measure is zero to 10 BAR (140psi) in six minutes with a door open, vehicle speed equal to zero. Check for leaks from the exhaust port when the compressor is running. This indicates a problem with the diaphragm valve or solenoid.

#### VEHICLE LEANS TO ONE SIDE

Using *Dynamic Tests*, verify that each sensor can meet its target value. Inspect the sensors for mechanical damage and range with TIB 60/05/95/US. The vehicle should not drop more than 15mm (0.6 in.) per day due to leakage.

#### THE COMPRESSOR CYCLES ON AND OFF FREQUENTLY

Leave door open to prevent height changes. The compressor should then run until the pressure switch closes or the thermal switch trips. Run a pressure switch test using TestBook if the compressor runs too long. Inspect height sensor readings for range and stability per TIB 60/05/95/US.

#### THE COMPRESSOR TURNED OFF AND WILL NOT RUN FOR SEVERAL MINUTES

The compressor has probably overheated. If the thermal trip (127°C) occurs, there will be a three-minute cool down period during which compressor operation will not occur. This cool down period can be overridden by turning the ignition off and allowing the system to power down.

#### THE VEHICLE IS SLOW TO LOWER

Perform a *Health Check*. There is either a restriction in a hose or the inlet valve is stuck open during the exhaust period. Use *Valve Cycling* and listen for valve clicking.



**NOTE:** There is no way to determine that the ECU is in a "cooling period." The *Compressor and Speeds* screen on TestBook can only monitor the active state of the thermal switch. Refer to Connector C333 detail.

#### COMPRESSOR NOT RUNNING WHEN "ON"

Under *Dynamic Tests/Compressor and Speeds*, the compressor does not follow the operation indicated by TestBook directly. Specifically, the compressor will stop for system leveling even though TestBook indicates that it is still ON. To correctly use this screen, leave a door open to prevent leveling (exhausting). Other problems could result from compressor or associated wiring. Trouble shoot with the ETM. Use *Valve Cycling* function on TestBook.



### SERVICE (NEW RANGE ROVER)

The most useful tool available to repair any EAS problem is TestBook. The system is only trying to make four sensors stay within a defined error range. Each rear sensor individually should be within 2 bits of the other. The same holds true for the front axle sensors.

The TestBook routine for New Range Rover starts out by checking for system fault messages before allowing access to the main menu. For this reason, it is useful at times to select the vehicle model as Range Rover Classic in order to use the main menu (e.g., to clear the Corrupt Sensor Data fault message). The TestBook menu offers the following utilities:

**CALIBRATE**—This routine should only be performed when a height sensor or ECU has been replaced.

**DEFLATE**—Used to depressurize the system, this function will not work if the inlet or exhaust solenoids have failed.

**DYNAMIC TESTS**—Provides real-time serial data for each subroutine.

- Heights and Valves—Height sensors data.
- Switches—All input switch data.
- Compressor and Speeds—Input and output data.

**HEALTH CHECK**—Read faults, performs complete system functionality test including pressure switch.

**TRANSPORT MODE**—Electronically locks the suspension into Access profile for speeds below 25 mph.

**HIGH LOCK MODE**—Electronically locks the suspension into High profile for speeds below 35 mph.

**VALVE CYCLING**—Used to manually open valves and run the compressor.

### SYSTEM CALIBRATION

In an effort to adjust for variations between sensors and their locations on the chassis, it is necessary to calibrate the system. Unlike Classic, this vehicle calibrates the chassis to the axles. Special blocks (LRT-60-003), which place the chassis at a known height above the axles where the corresponding sensor bit counts are recorded, accomplish this.

It may be necessary at times to select the vehicle model as Range Rover Classic to enable direct access to air suspension main menu. This is very useful when difficulties are experienced when trying to clear a Corrupt Sensor Data fault message. However, do not attempt to calibrate a late model Range Rover using a Classic routine. Refer to TIB 60/02/94/US.

At the start of the routine, all existing sensor values are overwritten with known default values. This way a consistent starting point is used for all vehicles. If the calibration routine is not successfully completed, the system will set a fault message for Corrupt Sensor Data. This means that the system is operating with default sensor data. This message can only be cleared by successfully completing a calibration. During the calibration routine both the pressure switch and the thermal switch are ignored. Complete the routine as quickly as possible in order to avoid potential compressor damage. When calibration is complete, there should be 100 ±4mm (4.0 ± .2 in.) between the front bump stop stud and the front axle pad, while the rear, measured similarly, should be 105 ±4mm (4.2± .2 in.) standard ride height.



NEW RANGE ROVER SERVICE cont.

### **SUMMARY OF AVAILABLE FAULT MESSAGES**

|                                |                                 |
|--------------------------------|---------------------------------|
| FRONT LEFT SENSOR OUT OF RANGE | FRONT RIGHT SENSOR OUT OF RANGE |
| REAR LEFT SENSOR OUT OF RANGE  | REAR RIGHT SENSOR OUT OF RANGE  |
| ENGINE SPEED                   | VEHICLE SPEED                   |
| PRESSURE SWITCH STUCK ON       | PRESSURE SWITCH STUCK OFF       |
| COMPRESSOR FAILURE             | CORRUPT SENSOR DATA             |
| CANNOT LOWER FRONT RIGHT       | CANNOT LOWER FRONT LEFT         |
| CANNOT LOWER REAR LEFT         | CANNOT LOWER REAR RIGHT         |
| FRONT RIGHT VALVE STUCK OPEN   | FRONT LEFT VALVE STUCK OPEN     |
| REAR RIGHT VALVE STUCK OPEN    | REAR LEFT VALVE STUCK OPEN      |
| EXHAUST VALVE STUCK OPEN       | INLET VALVE STUCK OPEN          |
| FRONT RIGHT VALVE STUCK CLOSED | FRONT LEFT VALVE STUCK CLOSED   |
| REAR RIGHT VALVE STUCK CLOSED  | REAR LEFT VALVE STUCK CLOSED    |
| EXHAUST VALVE STUCK CLOSED     | INLET VALVE STUCK CLOSED        |

### **ECU SELF DIAGNOSTIC LIMITATIONS**

The ECU may seem to misdiagnose a problem. This is due to the limited number of inputs on which to base decisions. Because of the similarity of symptoms, multiple faults may be registered where only one is actually present. The following is a summary of alternative interpretations of a registered fault message:

- Height sensor above or below has no alternatives.
- Engine speed has no alternatives.
- Road speed has no alternatives.
- Front valve stuck open has no alternatives.
- Rear valve stuck open has no alternatives.
- Inlet valve stuck open has no alternatives.
- Pressure switch on may be confused with inlet valve stuck closed or rear valve stuck closed.
- Pressure switch stuck off may be confused with compressor failure.
- Compressor failure may be confused with inlet valve stuck closed, exhaust valve stuck open.
- Front valve stuck closed may be confused with inlet valve stuck closed or exhaust valve stuck closed.



NEW RANGE ROVER SERVICE cont.

- Rear valve stuck closed may be confused with inlet valve stuck closed or exhaust valve stuck closed.
- Exhaust valve stuck closed may be confused with front valve stuck closed or rear valve stuck closed.

Pay particular attention to sensor outputs over the vehicle's range of suspension travel (See TIB 60/05/95).

Perform *System Test*. TestBook will generally find the problem.

The diagnostics following will be broken up into two categories:

**FAULT MESSAGE DIAGNOSIS** –This will give an explanation of what sets the message and some suggested TIB references as well as information relevant to the message.

**SYMPTOM DIAGNOSIS** –To be used in case of the absence of fault messages or warning lamp illumination. Probable causes of symptoms will be provided.





NEW RANGE ROVER SERVICE cont.

### FAULT MESSAGE DIAGNOSIS

#### ANY HEIGHT SENSOR ABOVE OR BELOW LIMIT

This is set when a specific sensor is detected operating outside of its allowable operating range. Select *Dynamic Tests/Heights and Valves* to view sensor readings (Use Range Rover Classic menu if necessary). Also refer to TIB 60/04/95/US to help locate the defective component.

Verify sensor readings over the entire range of suspension travel. The lower limit is 40 bit counts and the upper limit is 225 bit counts.

#### ANY CORNER VALVE STUCK OPEN, CLOSED, OR CANNOT LOWER

Set when the system is unable to make a sensor's output reach its demanded value. Select *Air Suspension/Valve Cycling* to determine whether the corner flagged will move up or down. Don't forget to run the compressor for a few minutes to build air pressure in the reservoir. If the corner moves, refer to TIB 60/05/95/US to locate the defective component. If it does not move, refer to TIB 60/09/94/US to determine specifically which component is at fault. It is highly unlikely that both the valve block and valve driver could fail at the same time.

#### INLET VALVE STUCK CLOSED OR EXHAUST VALVE STUCK OPEN

This is set when the system is unable to make more than one sensor's output reach its demanded value. An air leak or a weak compressor could also set this. Select *Dynamic Tests/Heights and Valves* to determine the cause.

#### INLET VALVE STUCK OPEN OR EXHAUST VALVE STUCK CLOSED

This is set when the system is unable to make more than one sensor's output reach its demanded value. Select *Dynamic Tests/Heights and Valves* to determine the cause. If operating in cold climates, refer to TIB 60/02/95/US.

#### PRESSURE SWITCH STUCK ON (CLOSED) OR OFF (OPEN)

These messages are set when the air usage does not correspond to the implied air pressure. Remember that the system has no way of determining the actual air pressure. Perform a Pressure switch test using TestBook and LRT-60-001 pressure gauge to verify switch operation.



**NOTE: Later version reservoirs will require adapter LRT-60-006 because of different sized drain plug.**

The results should be open to closed at 10 BAR (140 psi) and closed to open at 8.5 BAR (125 psi). If the system is empty it should take roughly 7.5 minutes to reach 10 BAR (140 psi) with the driver's door open.

#### ENGINE SPEED OR VEHICLE SPEED

These messages are set when the ECU sees values for either speed above a set limit (Vehicle speed 160 mph, engine speed 8,000 rpm). Use any icon under *Dynamic Tests* to locate the problem.

#### COMPRESSOR FAILURE

This message is set when the system is unable to bring more than one sensor to its target and the pressure switch remained off during that time. The system has no way of knowing if the compressor is operating. Use *Health Check* and *Dynamic Tests* to locate the cause.



NEW RANGE ROVER SERVICE cont.

### SYMPTOM DIAGNOSIS

#### THE SYSTEM WILL NOT INITIALIZE

Verify that the delay relay is powering the system. This can be observed by watching the lamp of the unlatched inhibit switch. Turn the ignition on, but do not start the engine. The switch lamp should illuminate if the ECU has power at pin 1. If not, check fuses 24 and 44 in the engine compartment. The lamp should go out when the remote button on the TestBook lead is depressed. Also check the TestBook VCSI current for a current flow of approximately 40 mA at fuse F33. Confirm that TestBook is functional by trying it on another vehicle.

#### THE COMPRESSOR DOES NOT RUN

All of the following must be true for the compressor to run:

- The engine speed must be greater than 500 rpm and then cannot drop below 150 rpm.
- The pressure switch must be open.
- The thermal switch must be off (closed, grounded).
- The exhaust valve must be closed, no height changes taking place.
- The compressor relay must be closed and the 30-amp 'maxifuse' MF2 must be intact.

#### SYSTEM DOES NOT BUILD PRESSURE FAST ENOUGH

Connect TestBook. Select *Air Suspension* and perform a *Health Check*. Use the pressure switch test to validate all system components. A rough measure is zero to 10 BAR (140 psi) in 7.5 minutes with any door or tailgate open, vehicle speed equal to zero. Check for leaks from the exhaust port when the compressor is running indicating a problem with the diaphragm valve or solenoid.

#### VEHICLE LEANS TO ONE SIDE

Using *Dynamic Tests*, verify that each sensor can meet its target value. Inspect the sensors for mechanical damage and range with TIB 60/05/95/US. The vehicle should not drop more than 15mm (.6 in.) per day due to leakage.

#### THE COMPRESSOR CYCLES ON AND OFF FREQUENTLY

Leave door or tailgate open to prevent height changes. The compressor should then run until the pressure switch closes or the thermal switch trips. Run a pressure switch test using TestBook if the compressor runs too long. Inspect sensor readings for range and stability with TIB 60/05/95/US.

#### THE COMPRESSOR TURNED OFF AND WILL NOT RUN FOR SEVERAL MINUTES

The compressor has probably overheated. If the thermal trip (127°C) occurs, there will be a three-minute cool down period during which compressor operation will not occur. This cool down period can be overridden by turning the ignition off and allowing the system to power down.

#### THE COMPRESSOR IS NOISY

Perform a system pressure test using TestBook to ensure that the compressor can build pressure properly. If the compressor is operating properly, check the compressor mounts. A new mounting system is currently under investigation. See TIB 60/06/95/US.



NEW RANGE ROVER SERVICE cont.

### THE VEHICLE IS SLOW TO LOWER

Inspect the exhaust filter for restriction. Perform a *Health Check*. There is either a restriction in a hose or the inlet valve is stuck open during the exhaust period. Use *Valve Cycling* and listen for valve clicking.



**NOTE:** There is no way to determine that the ECU is in a “cooling period.” The *Compressor and Speeds* screen on TestBook can only monitor the active state of the thermal switch. Refer to Connector C151 detail.

### COMPRESSOR NOT RUNNING WHEN “ON”

Under *Dynamic Tests/Compressor and Speeds*, the compressor does not follow the operation indicated by TestBook directly. Specifically, the compressor will stop for system leveling even though TestBook indicates that it is still ON. To correctly use this screen, leave a door or tailgate open to prevent leveling (exhausting). Other problems could result from compressor or associated wiring. Trouble shoot with the ETM. Use *Valve Cycling* function on TestBook.

## RANGE ROVER CLASSIC CONNECTOR DETAILS

△ **NOTE:** Range Rover Classic connectors shown are for 1995 MY vehicles. Most descriptions and colors are the same for 1993 MY and 1994 MY, but connector numbers may differ. Refer to the ETM for clarification if required.

### C256 Up Switch

| Position | Color         | Description                   |
|----------|---------------|-------------------------------|
| 1.       | Red/Brown     | Switch Illumination           |
| 2.       | Black         | Ground E201                   |
| 3.       | Yellow/Red    | Status Lamp Signal ECU pin 25 |
| 4.       | Yellow/Blue   | Switch Common ECU pin 29      |
| 5.       | Yellow/Brown  | Switch Signal to ECU pin 32   |
| 6.       | Blue/Lt Green | Status Lamp Power F14         |

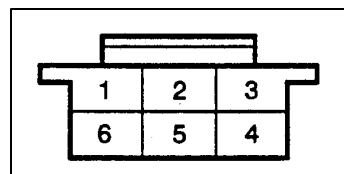

### C257 Inhibit Switch

| Position | Color        | Description                     |
|----------|--------------|---------------------------------|
| 1.       | Yellow/Slate | Status Switch Signal ECU pin 15 |
| 2.       | Yellow/Blue  | Switch Common ECU pin 29        |
| 3.       | Black        | Ground E201                     |
| 4.       | -            | -                               |
| 5.       | Slate        | Status Lamp Power F14           |
| 6.       | Red/Brown    | Switch Illumination             |

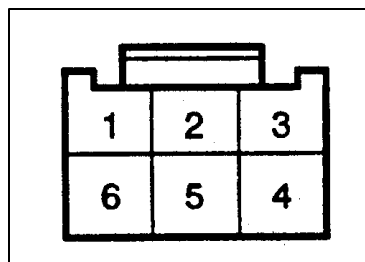

### C258 Down Switch

| Position | Color         | Description                  |
|----------|---------------|------------------------------|
| 1.       | Red/Brown     | Switch Illumination          |
| 2.       | Black         | Ground E201                  |
| 3.       | Yellow/White  | Status Lamp Signal ECU pin 7 |
| 4.       | Yellow/Blue   | Switch Common ECU pin 29     |
| 5.       | Yellow/Orange | Switch Signal ECU pin 33     |
| 6.       | Lt Green      | Status Lamp Power F14        |

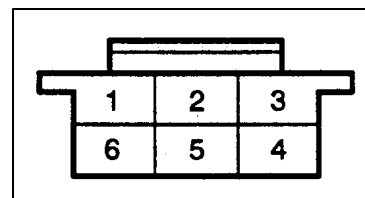



△ NOTE: Range Rover Classic connectors shown are for 1995 MY vehicles. Most descriptions and colors are the same for 1993 MY and 1994 MY, but connector numbers may differ. Refer to the ETM for clarification if required.

**C311 Main Harness Connector**

| Position | Color        | Description   |
|----------|--------------|---|
| 1.       | -            | -   |
| 2.       | White/Yellow | Key-on Power to Delay Relay                         |
| 3.       | Black        | Ground E300   |
| 4.       | Orange/White | Battery Power Feed                                  |
| 5.       | White/Slate  | Engine Speed, Alternator Tap                        |
| 6.       | Black/Blue   | Hand Brake Input (Manual Transmission <i>only</i> ) |
| 7.       | -            | -   |
| 8.       | -            | -   |
| 9.       | Black/Red    | Park Input, OV in Park                              |
| 10.      | Purple/Blue  | Door Input from MFU, Grounded when Open             |
| 11.      | Brown/Pink   | Power Feed to 30A maxifuse                          |
| 12.      | Green/Purple | Brake Input, 12V Brakes Applied                     |
| 13.      | Yellow/Pink  | Road Speed, 12V Square wave                         |
| 14.      | -            | -   |

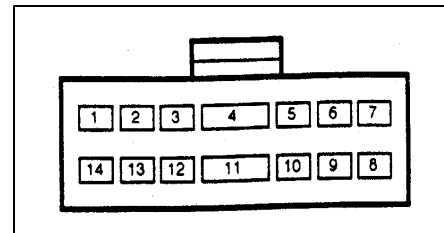

**C330 Switch Harness Connector**

| Position | Color         | Description                     |
|----------|---------------|---------------------------------|
| 1.       | -             | -                               |
| 2.       | Yellow        | Instrument Cluster Lamp Control |
| 3.       |               |                                 |
| 4.       |               |                                 |
| 5.       | Yellow/Blue   | Switch Common                   |
| 6.       | Yellow/Red    | Up lamp Signal                  |
| 7.       | -             | -                               |
| 8.       | -             | -                               |
| 9.       | Yellow/Brown  | Up Switch Input                 |
| 10.      | Yellow/Slate  | Inhibit Switch Input            |
| 11.      | Yellow/White  | Down Lamp Signal                |
| 12.      | Yellow/Orange | Down Switch Input               |
| 13.      | -             | -                               |

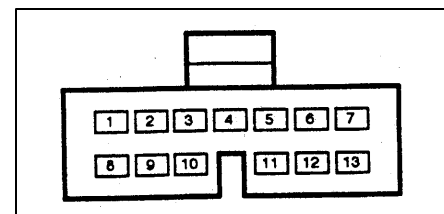



△ NOTE: Range Rover Classic connectors shown are for 1995 MY vehicles. Most descriptions and colors are the same for 1993 MY and 1994 MY, but connector numbers may differ. Refer to the ETM for clarification if required.

### C332 Valve Block Connector

| Position | Color          | Description                          |
|----------|----------------|--------------------------------------|
| 1.       | Green/White    | Rear left Valve, 12V to Open Valve   |
| 2.       | Green/Yellow   | Rear right Valve, 12V to Open Valve  |
| 3.       | Green/Brown    | Front left Valve, 12V to Open Valve  |
| 4.       | Green/Pink     | Front right Valve, 12V to Open Valve |
| 5.       | Green/Slate    | Inlet Valve, 12V to Open Valve       |
| 6.       | Green/Orange   | Exhaust Valve, 12V to Open Valve     |
| 7. *     | Slate/Green    | Pressure Switch 12V Power            |
| 8.       | Brown/Lt Green | Diaphragm Valve, 12V to Open Valve   |
| 9. *     | Slate/Blue     | Pressure Switch 12V Signal to ECU    |
| 10.      | Black          | Ground                               |
| 11.      | Black          | Ground                               |
| 12.      | Slate/Red      | 12V Power from Delay Relay           |
| 13.      | Slate/Red      | 12V Power from Delay Relay           |

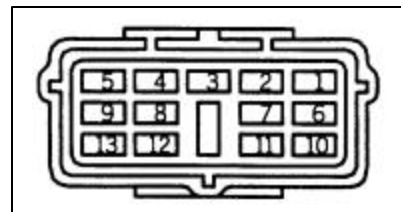

\* For vehicles with valve block mounted switch.

### Valve Block to Valve Driver Connector (Not shown in ETM)

| Position | Color       | Description                            |
|----------|-------------|--|
| 1        | White       | Rear Left Valve Hit and Drop Control   |
| 2        | Red/White   | Rear Left Valve 12 Volt                |
| 3        | -           | -                                      |
| 4        | Red/Orange  | Exhaust Valve 12 Volt                  |
| 5        | Orange      | Exhaust Valve Hit and Drop Control     |
| 6        | Red/Brown   | Front Left Valve 12 Volt               |
| 7        | Red/Black   | Inlet Valve 12 Volt                    |
| 8        | Pink        | Front Right Valve Hit and Drop Control |
| 9        | Yellow      | Rear Right Valve Hit and Drop Control  |
| 10       | Brown       | Front Left Valve Hit and Drop Control  |
| 11       | Slate       | Inlet Valve Hit and Drop Control       |
| 12       | Red/Pink    | Front Right Valve 12 Volt              |
| 13       | Red/L Green | Rear Right Valve 12 Volt               |

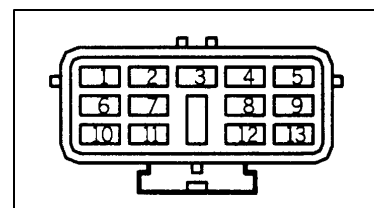



△ **NOTE: Range Rover Classic connectors shown are for 1995 MY vehicles. Most descriptions and colors are the same for 1993 MY and 1994 MY, but connector numbers may differ. Refer to the ETM for clarification if required.**

**C333 Compressor Connector**

| Position | Color         | Description  |
|----------|---------------|--|
| 1.       | -             | -  |
| 2.       | Black/Orange  | Thermal Switch Monitor, Open to Enter Cooling Period |
| 3.       | Black         | Ground E300  |
| 4.       | Brown/L Green | Power from Compressor Relay                          |

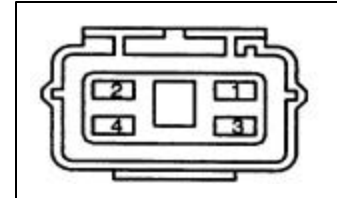

**Typical Height Sensor: C359, C360, C432, and C433**

| Position | Color         | Description                                      |
|----------|---------------|--|
| 1.       | Refer to C331 | Height Sensor Source, 5V from ECU                |
| 2.       | Refer to C331 | Height Sensor Wiper, Voltage is Height dependent |
| 3.       | Black/Slate   | Height Sensor Ground                             |

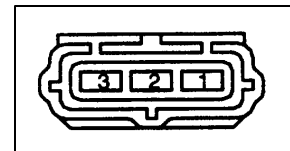

**C362 Delay Relay Connector**

| Position | Color        | Description   |
|----------|--------------|---|
| 30       | Orange/White | Battery Power from F6 (15A Fuse in Satellite Box 2) |
| 85       | Black/Pink   | Ground Through Diagnostic Connector                 |
| 86       | White/Yellow | Key-on Power from F13 (10A Fuse in Fascia Fusebox,  |
| 87       | Slate/Red    | Power to ECU, Valve Block, and Pressure Switch      |
| 87a      | Purple/Blue  | Door Input from MFU, Grounded when Open             |

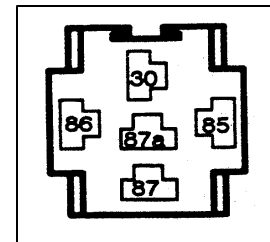

**C365 Diagnostic Connector**

| Position | Color         | Description                           |
|----------|---------------|---------------------------------------|
| 1.       | White/Pink    | Serial Communications RECEIVE         |
| 2.       | -             | -                                     |
| 3.       | Black/Pink    | Ground to Pin 85 of Delay Relay, C362 |
| 4.       | White/L Green | Serial Communication TRANSMIT         |
| 5.       | Black         | Ground                                |

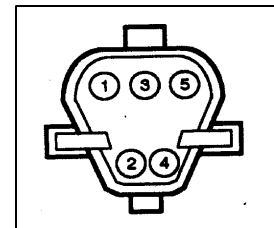

**C377 Pressure Switch Connector (switch on reservoir)**

| Position | Color       | Description                          |
|----------|-------------|--------------------------------------|
| 1.       | Slate/Green | 12V from Delay Relay via 1K Resistor |
| 2.       | Slate/Blue  | Output, 12V when Closed              |

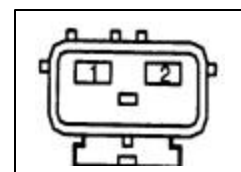



## EAS - System Information Document

RANGE ROVER CLASSIC

See note on previous page.

### C331 ECU Connector

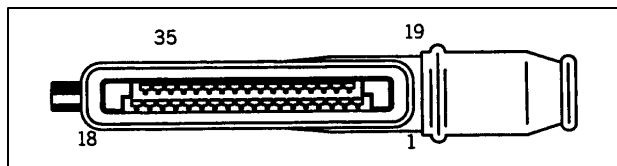

| Position | Color          | Description   |
|----------|----------------|---|
| 1.       | Slate/Red      | Power from Delay relay                                      |
| 2.       | Orange/Blue    | Rear Left Height Sensor Source 5V                           |
| 3.       | Orange/Black   | Front Left Height Sensor Source 5V                          |
| 4.       | Red/Blue       | Rear Left Height Sensor Input Voltage                       |
| 5.       | Red/Black      | Front Left Height Sensor Input Voltage                      |
| 6.       | Black/Yellow   | Warning Lamp Relay Control, Ground to Turn Lamp OFF         |
| 7.       | Yellow/White   | Down Lamp, Ground to Illuminate                             |
| 8.       | Slate/Yellow   | Compressor Relay Driver                                     |
| 9.       | Green/Orange   | Exhaust Valve, 12V to Open Valve                            |
| 10.      | Green/Brown    | Front Left Valve, 12V to Open Valve                         |
| 11.      | Green/White    | Rear Left Valve, 12V to Open Valve                          |
| 12.      | White/Slate    | Engine Speed Input, Alternator Phase Tap                    |
| 13.      | Slate/Blue     | Pressure Switch Input, 12V when Switch Closed               |
| 14.      | Purple/Red     | Park/Hand Brake Input, Ground to enable Access Mode         |
| 15.      | Yellow/Slate   | Inhibit Switch Input, Connects to Pin 29 when Inhibited     |
| 16.      | Black/Orange   | Thermal Switch Monitor, Open Circuit to Begin Cooling Cycle |
| 17.      | White/Pink     | Serial Communications RECEIVE                               |
| 18.      | Black          | Ground, E300  |
| 19.      | Slate          | Warning Lamp Relay Source, 12V to Turn Lamp OFF             |
| 20.      | Orange/Yellow  | Rear Right Height Sensor Source 5V                          |
| 21.      | Orange/Pink    | Front Right Height Sensor Source 5V                         |
| 22.      | Red/Yellow     | Rear Right Height Sensor Input Voltage                      |
| 23.      | Orange/Pink    | Front Right Height Sensor Input Voltage                     |
| 24.      | Black/Slate    | Height Sensor Ground  |
| 25.      | Yellow/Red     | Up Lamp, Ground to Illuminate                               |
| 26.      | Green/Slate    | Inlet Valve, 12V to Open Valve                              |
| 27.      | Green/Pink     | Front Right Valve, 12V to Open Valve                        |
| 28.      | Green/Yellow   | Rear Right Valve, 12V to Open Valve                         |
| 29.      | Yellow/Blue    | Height Switch Common  |
| 30.      | Yellow/Pink    | Road Speed Input, 12V Square Wave, 8,000 Pulses per Mile    |
| 31.      | Green/Purple   | Brake Switch Input, 12V with Brakes Applied                 |
| 32.      | Yellow/Brown   | Up Switch Input, Connects to Pin 29 when Pressed            |
| 33.      | Yellow/Orange  | Down Switch input, Connects to Pin 29 when Pressed          |
| 34.      | Purple/Slate   | Door Input, Ground with Door Open or Disable Switch ON      |
| 35.      | White/L. Green | Serial Communications TRANSMIT                              |



## NEW RANGE ROVER CONNECTOR DETAILS

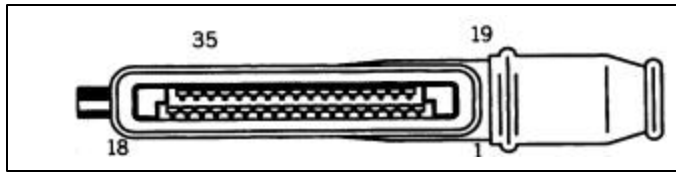

**C117 ECU Connector**

| Position | Color          | Description   |
|----------|----------------|---|
| 1.       | Slate/Green    | Power from Delay relay  |
| 2.       | Orange/Slate   | Rear Left Height Sensor Source 5V                                   |
| 3.       | Orange/Blue    | Front Left Height Sensor Source 5V                                  |
| 4.       | Orange/Pink    | Rear Left Height Sensor Input Voltage                               |
| 5.       | Orange/Green   | Front Left Height Sensor Input Voltage                              |
| 6.       | -              | -   |
| 7.       | Blue/Pink      | Lamp Control and Message to BeCM                                    |
| 8.       | Green          | Compressor Relay Driver   |
| 9.       | Green/Slate    | Exhaust Valve, 12V to Open Valve                                    |
| 10.      | Green/Black    | Front Left Valve, 12V to Open                                       |
| 11.      | Green/White    | Rear Left Valve, 12V to Open Valve                                  |
| 12.      | Slate          | Engine Speed Input, from BeCM C114                                  |
| 13.      | Slate/Blue     | Pressure Switch Input, 12V when Switch Closed                       |
| 14.      | Black/Pink     | Park/Hand Brake Input, From BeCM C112, Ground to enable Access Mode |
| 15.      | Yellow/Slate   | Inhibit Switch Input, Ground when pressed                           |
| 16.      | Black/Purple   | Thermal Switch Monitor, Open Circuit to Begin Cooling Cycle         |
| 17.      | White/Pink     | Serial Communications RECEIVE                                       |
| 18.      | Black          | Ground E154   |
| 19.      | -              | -   |
| 20.      | Orange/Red     | Rear Right Height Sensor Source 5V                                  |
| 21.      | Orange/Pink    | Front Right Height Sensor Source 5V                                 |
| 22.      | Orange/Brown   | Rear Right Height Sensor Input Voltage                              |
| 23.      | Orange/Yellow  | Front Right Height Sensor Input Voltage                             |
| 24.      | Black/Pink     | Height Sensor Ground  |
| 25.      | Blue/White     | Lamp Control and Message to BeCM                                    |
| 26.      | Green/Orange   | Inlet Valve, 12V to Open Valve                                      |
| 27.      | Green/Pink     | Front Right Valve, 12V to Open Valve                                |
| 28.      | Green/Yellow   | Rear Right Valve, 12V to Open Valve                                 |
| 29.      | -              | -   |
| 30.      | Yellow         | Road Speed Input from BeCM C112, 12V square Wave                    |
| 31.      | Green/Purple   | Brake Switch Input, 12V with Brakes Applied                         |
| 32.      | Yellow/Orange  | Up Switch Input, Ground when Pressed                                |
| 33.      | Yellow/Brown   | Down Switch Input, Ground when Pressed                              |
| 34.      | Purple/Slate   | Door Input from BeCM C112, Ground with Door Open                    |
| 35.      | White/L. Green | Serial Communications TRANSMIT                                      |



NEW RANGE ROVER

## C118 Delay Relay Connector

| Position | Color         | Description                                       |
|----------|---------------|---|
| 1        | -             | -   |
| 2        | Purple/Red    | Battery Power from 10A F44                        |
| 3        | Slate/Red     | Relay Interrupt from C231, Pull Low to Open Relay |
| 4        | White         | Key ON Signal from 5A F24                         |
| 5        | Purple/Orange | Door Input to Wake Up if Key is Off               |
| 6        | Black         | Ground, E148                                      |
| 7        | -             | -   |
| 8        | Slate/Green   | Power to ECU, Valve Block, and Pressure Switch    |
| 9        | -             | -   |

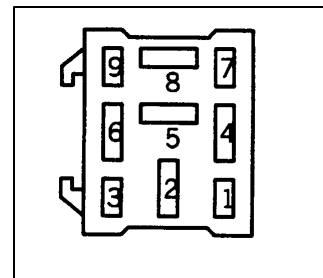

## C139 Valve Block to Valve Driver Connector

| Position | Color       | Description                            |
|----------|-------------|--|
| 14       | White       | Rear Left Valve Hit and Drop Control   |
| 15       | Red/White   | Rear Left Valve 12 Volt                |
| 16       | -           | -                                      |
| 17       | Red/Orange  | Exhaust Valve 12 Volt                  |
| 18       | Orange      | Exhaust Valve Hit and Drop Control     |
| 19       | Red/Brown   | Front Left Valve 12 Volt               |
| 20       | Red/Black   | Inlet Valve 12 Volt                    |
| 21       | Pink        | Front Right Valve Hit and Drop Control |
| 22       | Yellow      | Rear Right Valve Hit and Drop Control  |
| 23       | Brown       | Front Left Valve Hit and Drop Control  |
| 24       | Slate       | Inlet Valve Hit and Drop Control       |
| 25       | Red/Pink    | Front Right Valve 12 Volt              |
| 26       | Red/L Green | Rear Right Valve 12 Volt               |

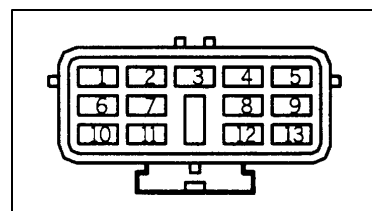

## C142 Diaphragm Valve Connector

| Position | Color | Description                     |
|----------|-------|---------------------------------|
| 1.       | Green | 12V Power from Compressor Relay |
| 2.       | Black | Ground to C152, Pin 11          |

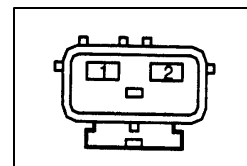

## C151 Compressor Connector

| Position | Color           | Description  |
|----------|-----------------|--|
| 1.       | -               | -  |
| 2.       | Black/Purple    | Thermal Switch Monitor, Open to Enter Cooling Period |
| 3.       | Black           | Ground, E154   |
| 4.       | Purple/Lt Green | Power Supply   |

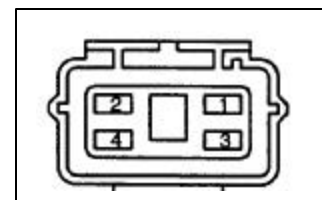



NEW RANGE ROVER

## C152 Valve Block Connector from ECU

| Position | Color           | Description                                |
|----------|-----------------|--|
| 1.       | Green/White     | Rear Left Valve, 12V to Open Valve         |
| 2.       | Green/Yellow    | Rear Right Valve, 12V to Open Valve        |
| 3.       | Green/Black     | Front Left Valve, 12V to Open Valve        |
| 4.       | Green/Pink      | Front Right Valve, 12V to Open Valve       |
| 5.       | Green/Orange    | Inlet Valve, 12V to Open Valve             |
| 6.       | Green/Slate     | Exhaust Valve, 12V to Open Valve           |
| 7.       | Slate/Green     | Delay Relay to Pressure Switch 12V Power   |
| 8.       | Purple/Lt Green | Diaphragm Valve, 12V to Open Valve         |
| 9.       | Slate/Blue      | Pressure Switch 12V Signal to ECU          |
| 10.      | Black           | Ground, E148                               |
| 11.      | Black           | Ground, E148                               |
| 12.      | Slate/Green     | 12V Power from Delay Relay to Valve Driver |
| 13.      | Slate/Green     | 12V Power from Delay Relay to Valve Driver |

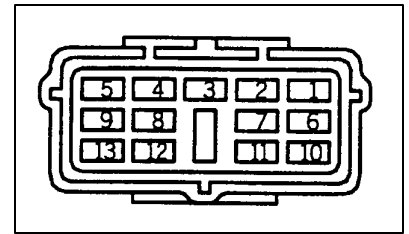

## C213 Rocker Switch Connector

| Position | Color         | Description                             |
|----------|---------------|---|
| 1.       | Blue/White    | Lamp control from BeCM C114, ECU Pin 25 |
| 2.       | Red/White     | Illumination                            |
| 3.       | White         | Power from BeCM 10A F17                 |
| 4.       | Blue/Pink     | Lamp Control from BeCM C114, ECU Pin 7  |
| 5.       | Purple/Black  | Wade Height Input to BeCM C114          |
| 6.       | Yellow/Brown  | Down Switch Input, Ground when Pressed  |
| 7.       | Black         | Ground E252                             |
| 8.       | Yellow/Orange | Up Switch Input, Ground When Pressed    |

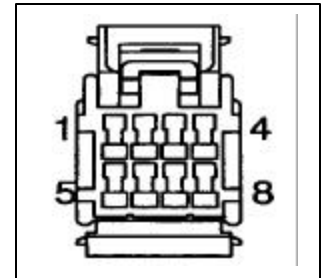

## C214 Inhibit Switch Connector

| Position | Color        | Description                      |
|----------|--------------|----------------------------------|
| 1.       | Black        | Ground E252                      |
| 2.       | Red/White    | Illumination                     |
| 3.       | Yellow/Slate | Jumper to Same Connector, Pin 5  |
| 4.       | Black        | Ground E252                      |
| 5.       | Yellow/Slate | Inhibit Input, Ground to Inhibit |
| 6.       | White        | Power from BeCM 10A F17          |

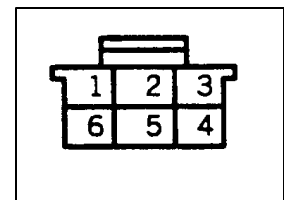

## Typical Height Sensor-C108, C146, C147, C168

| Position | Color         | Description                                      |
|----------|---------------|--|
| 1.       | Refer to C117 | Height Sensor Source, 5V from ECU                |
| 2.       | Refer to C117 | Height Sensor Wiper, Voltage is Height dependent |
| 3.       | Black/Pink    | Height Sensor Ground                             |

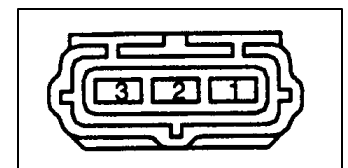



## PNEUMATIC DIAGRAMS

The following diagrams apply to New Range Rover. As stated before, the Classic system is essentially the same with the exception of extension pipes for the exhaust silencer and inlet filter. Additionally, later Classics had the pressure switch located on the valve block.

**Range Rover Classic Valve Block Quick Reference Table**

| Port Number | Destination                                    | Color Tag           |
|-------------|--|---------------------|
| 1.          | Rear Left Air Spring                           | Red                 |
| 2.          | Rear Right Air Spring                          | Blue                |
| 3.          | Front Left Air Spring                          | Yellow              |
| 4.          | Front Right Air Spring                         | Green               |
| 5.          | Dryer  | -                   |
| 6.          | Reservoir                                      | Brown               |
| 7.          | Dryer  | -                   |
| 8.          | Pressure relief                                | Screw-on Valve      |
| 9.          | Exhaust  | Violet              |
| 10.         | Compressed Air Inlet                           | Compression fitting |
| 11.         | Diaphragm Exhaust                              | -                   |
| 12.         | Pressure Switch (with later style valve block) | Screw-on switch     |

**New Range Rover Valve Block Quick Reference Table**

| Port Number | Destination            | Color Tag           |
|-------------|------------------------|---------------------|
| 1.          | Rear Left Air Spring   | Red                 |
| 2.          | Rear Right Air Spring  | Blue                |
| 3.          | Front Left Air Spring  | -                   |
| 4.          | Front Right Air Spring | Green               |
| 5.          | Dryer                  | -                   |
| 6.          | Reservoir              | Violet              |
| 7.          | Dryer                  | -                   |
| 8.          | Pressure Relief        | Screw-on Valve      |
| 9.          | Exhaust                | Screw-on Filter     |
| 10.         | Compressed Air Inlet   | Compression Fitting |
| 11.         | Diaphragm Exhaust      | -                   |
| 12.         | Pressure Switch        | Screw-on Switch     |

## Compressor recharging reservoir

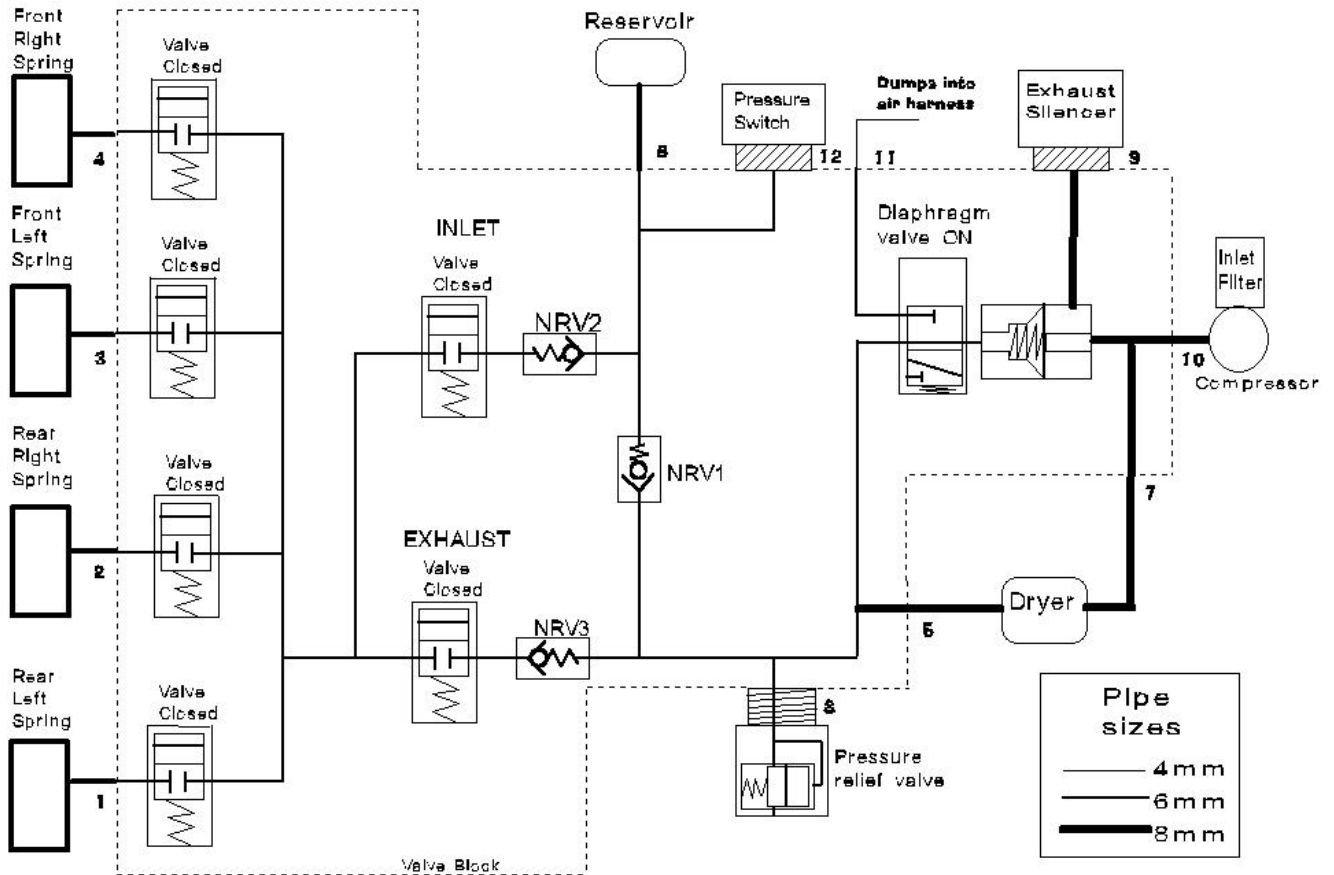

1. Air compressor runs and supplies pressure to system.
2. Diaphragm solenoid is ON.
3. The diaphragm valve is closed forcing air through the dryer and into valve block.
4. The inlet valve is closed forcing air through to the reservoir.
5. The pressure switch turns off the compressor when specified pressure is achieved.

## Deflating rear springs

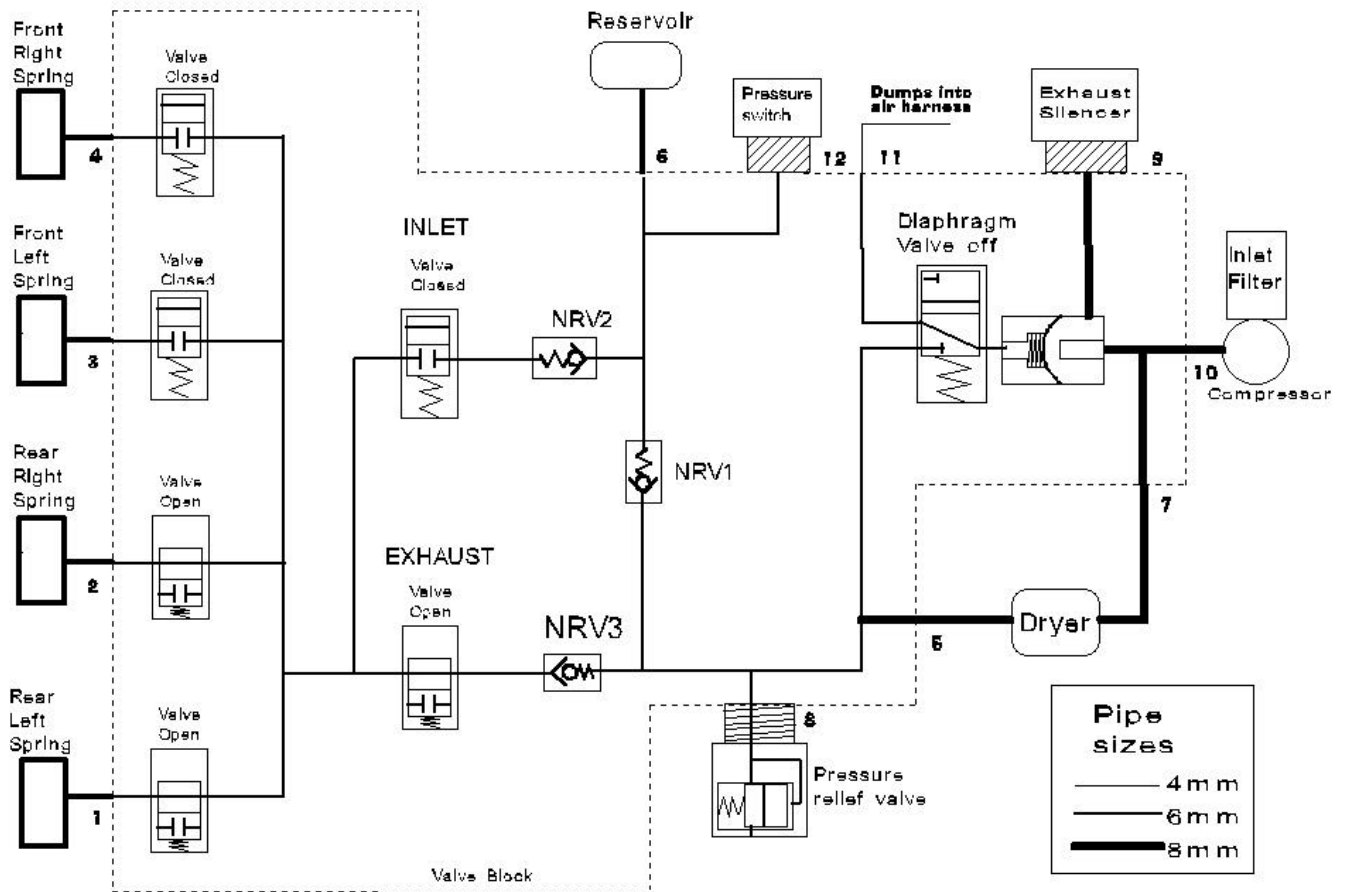

1. The rear air spring valves are opened allowing air pressure to escape.
2. The inlet valve is closed and the exhaust valve is opened to allow pressure to escape.
3. The diaphragm solenoid is OFF allowing the diaphragm valve to lift off its seat and pass air to the exhaust silencer.

## Inflating the rear springs with compressor off

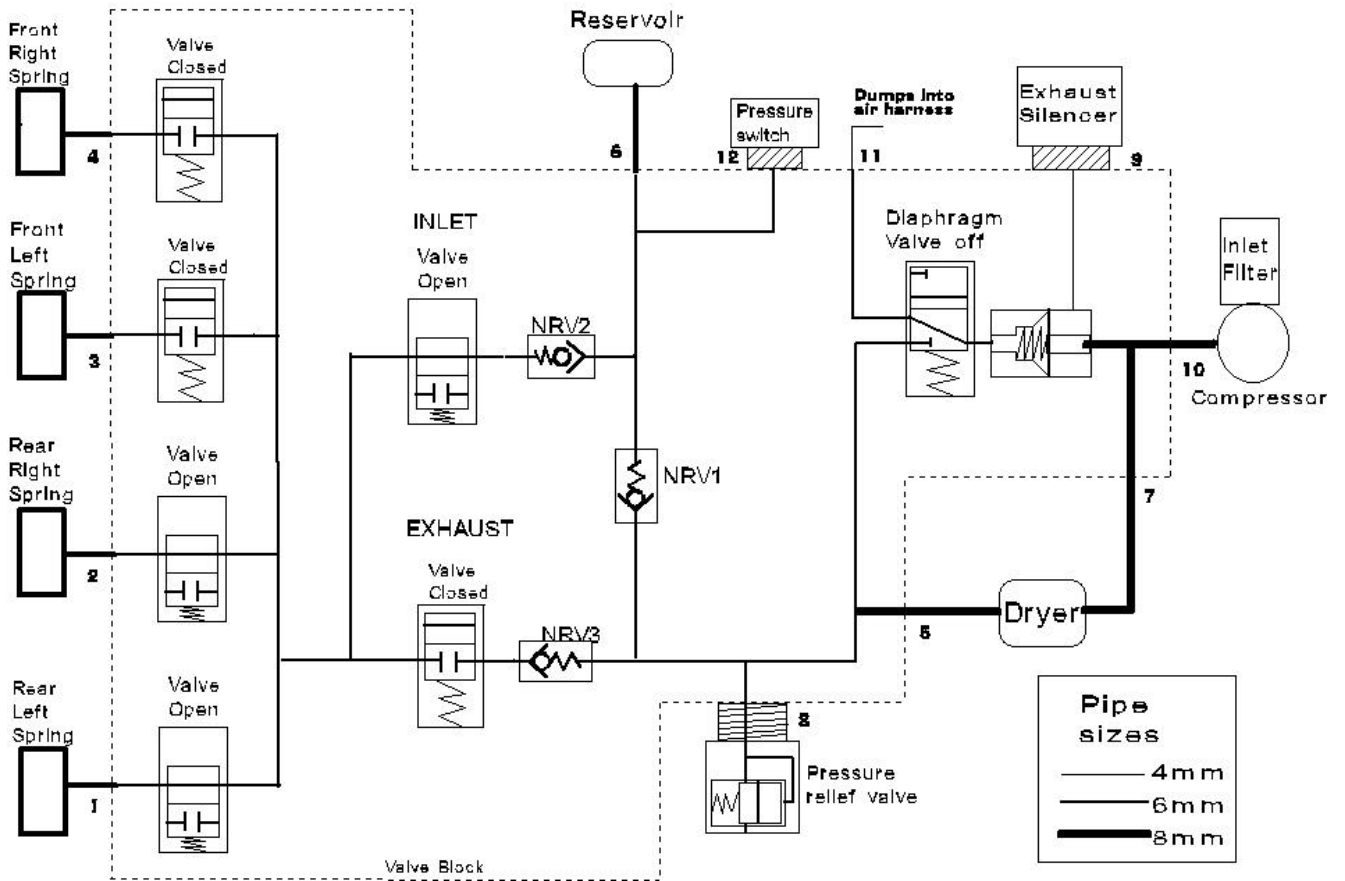

1. The inlet valve opens and allows air pressure into system from the reservoir.
2. The rear valves open and allow pressure into the air springs.



## EXPECTED HEIGHT SENSOR BIT COUNTS

### Range Rover Classic

| <b>Ride State</b> | <b>Front Sensor Range (bits)</b> | <b>Rear Sensor Range (bits)</b> |
|-------------------|----------------------------------|---------------------------------|
| High              | 110-155                          | 105-150                         |
| Standard          | 90-125                           | 100-125                         |
| Access            | 50-100                           | 50-100                          |

### New Range Rover

| <b>Ride State</b> | <b>Front Sensor Range (bits)</b> | <b>Rear Sensor Range (bits)</b> |
|-------------------|----------------------------------|---------------------------------|
| High              | 120-180                          | 105-150                         |
| Standard          | 95-150                           | 85-130                          |
| Low               | 75-140                           | 75-120                          |
| Access            | 50-110                           | 50-100                          |